

JOBO

FOR YOUR BEST IMAGE

Quick Start Guide

Photo Display

1 Connection 2 Setting 3 Operation 4 Content



MORE THAN 80 YEARS OF PHOTO EXPERIENCE WWW.JOBO.COM

ENGLISH

Connection

1

A Attach stand

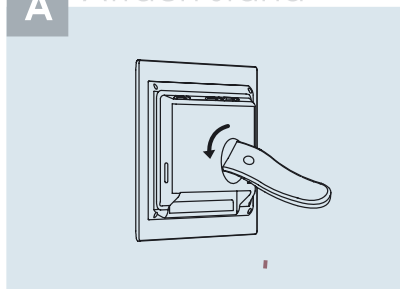

- Place the head of the stand in the socket
- Rotate clockwise until the stand chock into place

B connect power

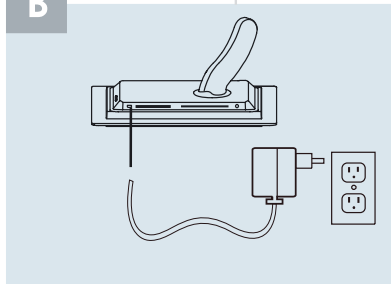

- Connect the supplied power adaptor to the photo display and then connect it to a power outlet.

C

Locate control keys

Use your photo display by pressing the control keys in the back. LCD display also shows the function icon for each key at the same position

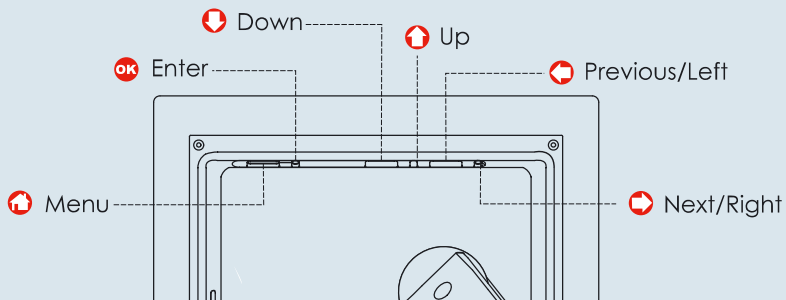

ENGLISH

Setting

2

A

Turn on the photo display

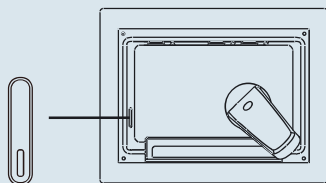

Photo display(back)



Photo display(front):Startup screen

- Push power button on the back of the frame
- >The system will be Boot no Startup screen will appear

B

Choose Language

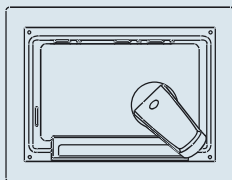

Photo display (back)
Menu buttons are on back of display



Photo display(front):Setup screen
Icons indicate position of buttons found on back of the plane

- Press , and keys to go to settings.
- Press , keys to select LANGUAGE settings, press key to enter
- Press , keys to select
- Press key to set your language
- Use key to return and exit SETUP

View Pre-stored photos



Browse mode
Manual viewing of photos
One-by-one



Thumbnail mode
List of all photos



Slideshow mode
Automatic, rotating
display of photos

- There are 3 view modes for you to choose from.
- Press , key to select PHOTO
Press key to enter
- Press , keys to select NAND-flash
Press key to enter
- Press , keys to select ALBUM
Press key to enter to THUMBNAİL MODE
then Press key to enter to Slideshow mode

View photos from your memory card

Photo frame (underside)

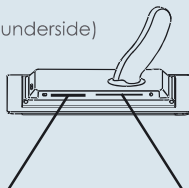

Use left slot for Memory Stick/Secure Digital/MMC/ xD card, slide Card in end first and face up

Use right slot for Compact Flash card, slide card in End first and face up



Photo frame (front):Thumbnail mode
After a few seconds photos on your memory card will appear

- Press , key to select PHOTO
Press key to enter
- Press , key to select STORAGE
Press key to enter
- Press , key to select ALBUM
Press key to enter in to THUMBNAİL MODE
then Press key to enter to Slideshow mode

Feature: If the memory card is inserted before the power is ON, Slideshow will automatically start.

ENGLISH

Copy one or copy all photos from your memory card



Photo frame(front):
Browse mode



Coping photo mode



Copied photo mode

- Use , keys to select photo
- Press key to copy photo
- Press , key to select copy one or copy all to inserted memory card
- Press key to copy
- >Photo frame will keep a resized copy of the photo until it's internal memory is full(show message)

Delete one or Delete all photos from photo display



Photo display(front):
Thumbnail mode



Delete photo mode

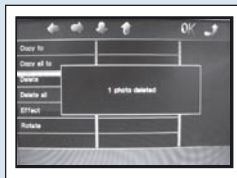

Delete finish photo mode

- Use , keys to select photo
- Press key to delete photo
- Press , key to select Delete or Delete all to inserted memory card
- Press key to delete then system will show finished

Delete photo mode

Set Time and Date functions



Photo display(front):
Set Time / Date mode



Set Time mode



Set date mode

- Press **↑**, **↓** keys to select SETUP
- Press **OK** key to enter
- Press **↑**, **↓** keys to select Time and Date
- Press **OK** key to enter
- Press **↑**, **↓** keys to select Time to setup
- Press **→** key to set hours , minutes and second
- Press **←** key to return main menu and exit SETUP
- Press **↑**, **↓** keys to select SETUP
- Press **OK** key to enter
- Press **↑**, **↓** keys to select Time and Date
- Press **OK** key to enter
- Press **↑**, **↓** keys to select Date to setup
- Press **→** key to set year, month and day
- Press **←** key to return main menu and exit SETUP

Set Auto on/off timer functions Photo display can be enabled to turn on and off at pre-set times daily



Photo display(front):
Set Auto on/off mode



Set on/off mode



Set on/off time mode

- Press **↑**, **↓** keys to select SETUP
- Press **OK** key to enter
- Press **↑**, **↓** keys to select Auto on/off
- Press **OK** key to enter
- Press **↑**, **↓** keys to select Set on/off to switch
- Press **OK** key to select On or Off then press enter
- Press **↑**, **↓** key to set auto on or auto off time
- Press **←** key to return main menu and exit SETUP



Quick start guide

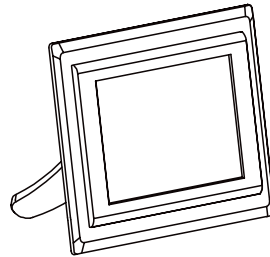

Digital Photo Frame

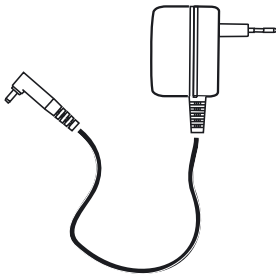

Power adaptor

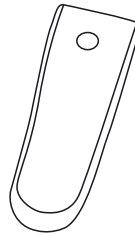

Frame Stand



USB Cable

Frequently Asked Questions

Q Is the LCD screen touch-enabled?

A The LCD screen is not touch-enabled. Use the keys in the back to control photo display.

Q After copying photos, how can I check if the photo are already stored inside?

A The photos are copied after the screen confirms with "photo copied" message. You may view pre-stored photos .

Q Can I switch between different photo slideshows photos by using different memory cards?

A Yes, photo display will show the slides show photos stored in the card currently connected.

Q Can I use phftp display to delete photos on memory card?

A Yes, it support operations to delete photos on external devices.

Q Can I print photos from photo dasplay

A No, it does not support direct photo printing.

Contact Us

JOBBO AG

D-51645 Gummersbach • Kölner Straße 58

Tel: +49 (0)2261 / 545-0 • Fax: +49 (0)2261 / 545-42

Mail: info@jobbo.com • www.jobbo.com